

Saab JAS 39

GRIPEN



570 mm



880 mm



220-250g



Li-pol
3s

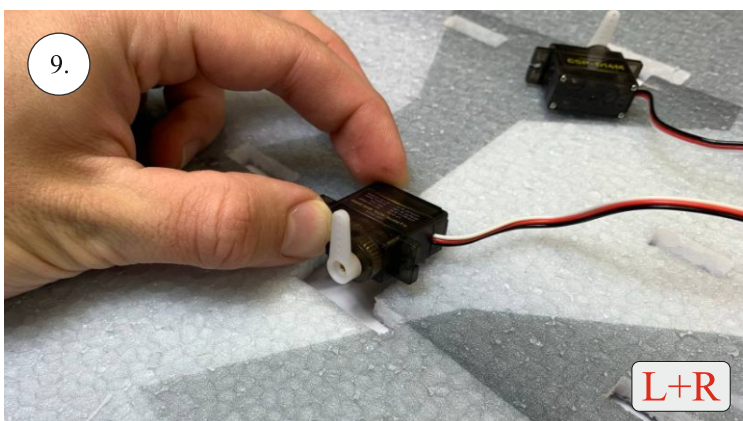
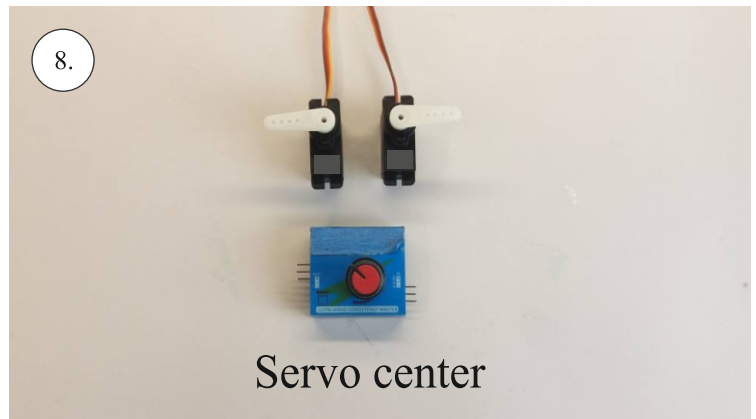
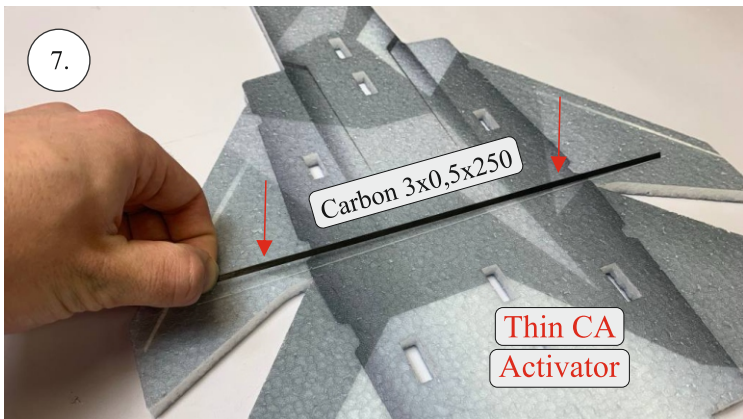
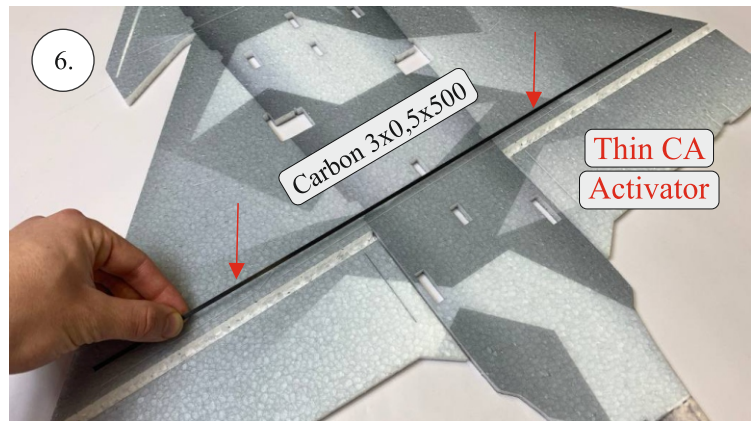
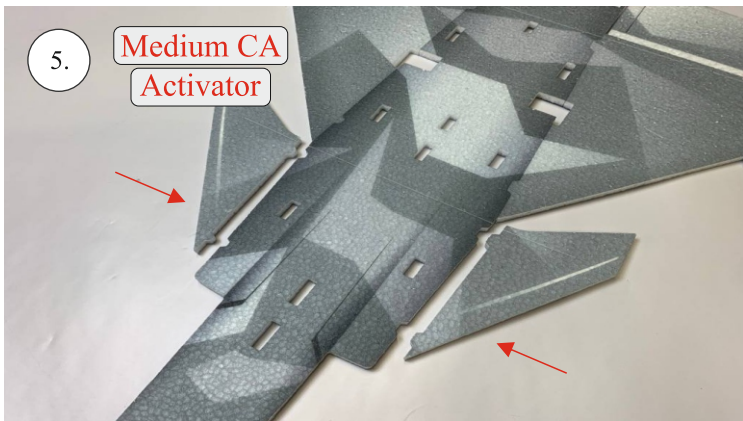
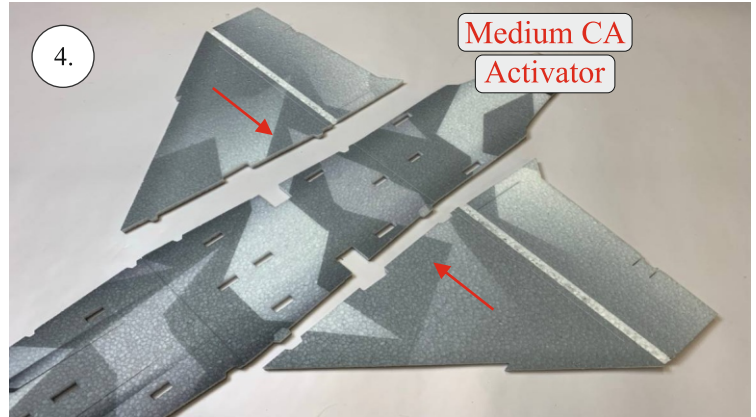
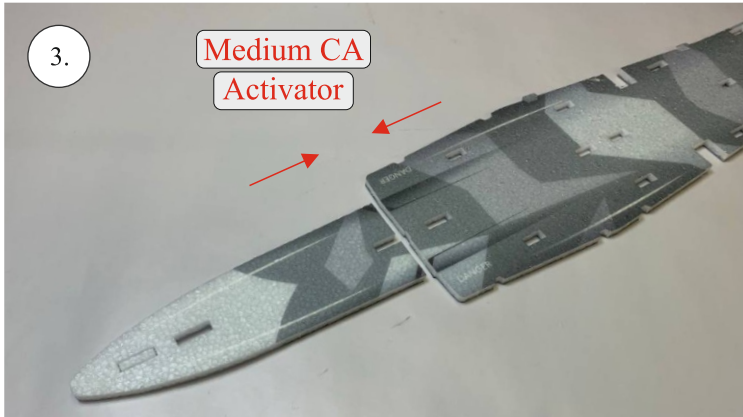
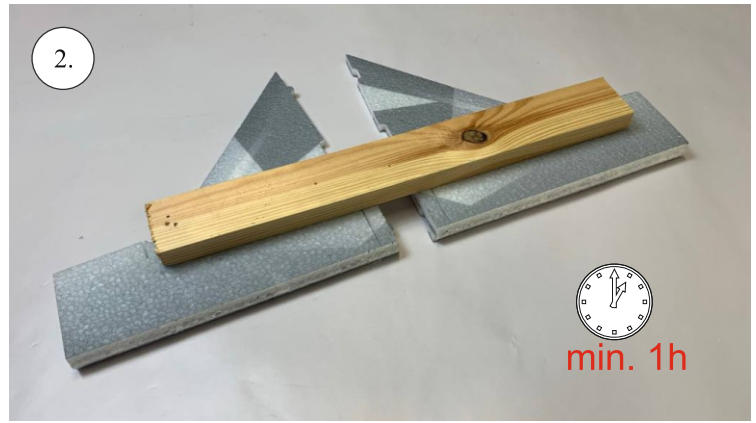

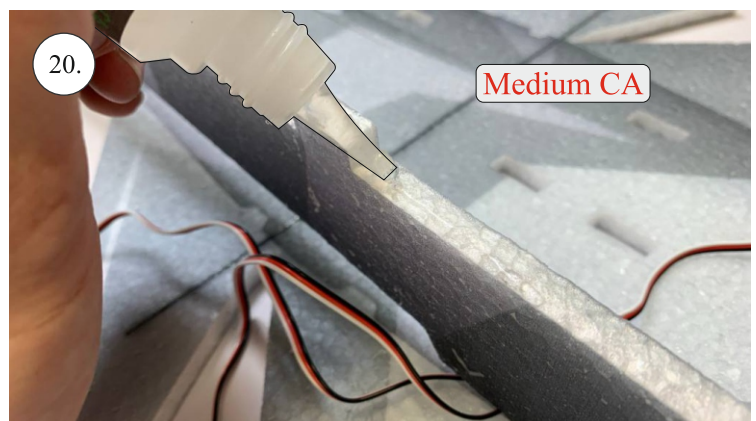
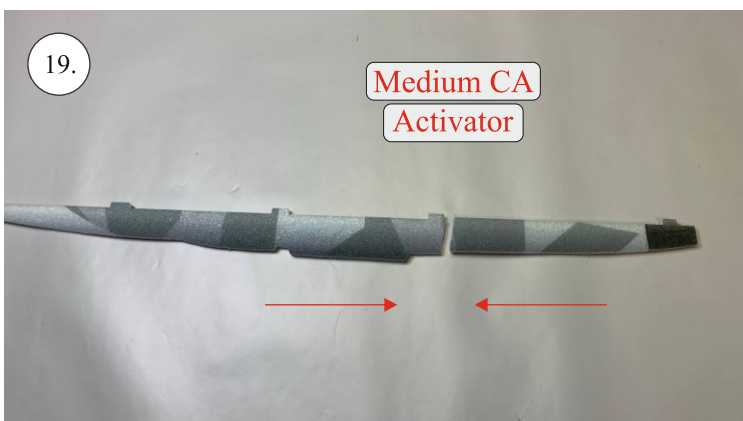
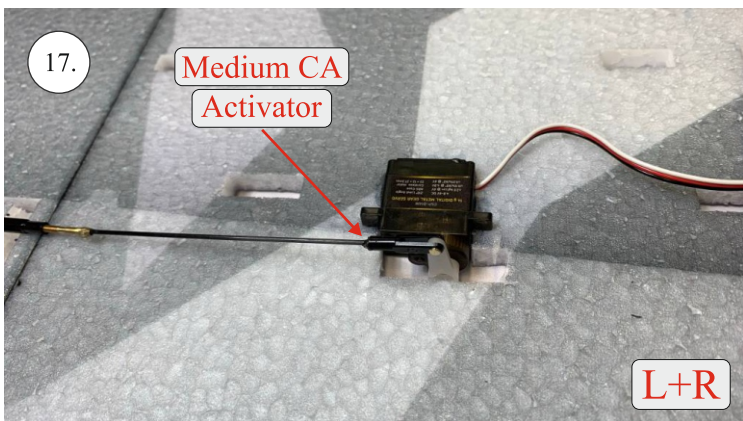
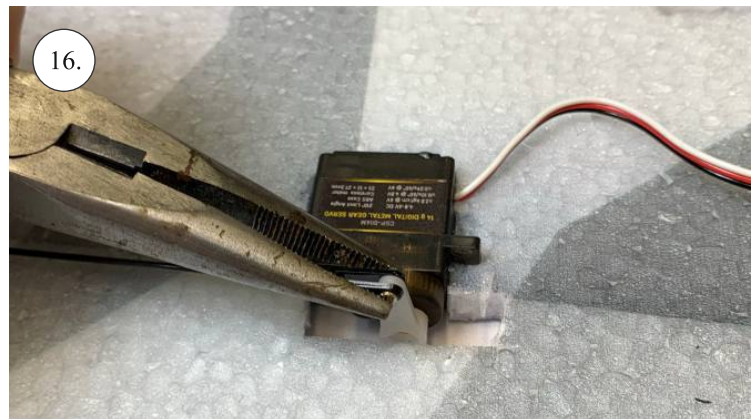
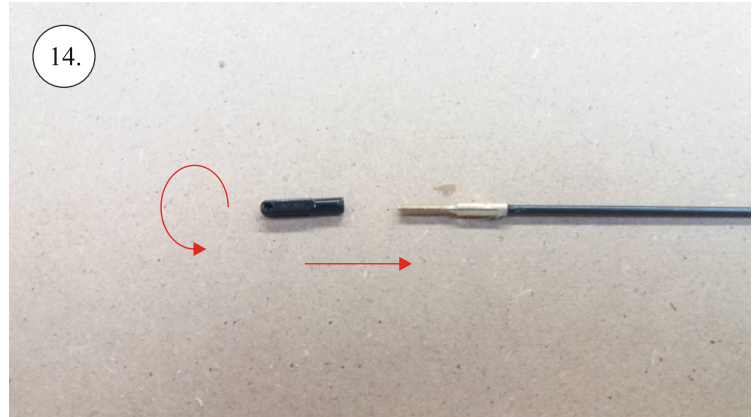
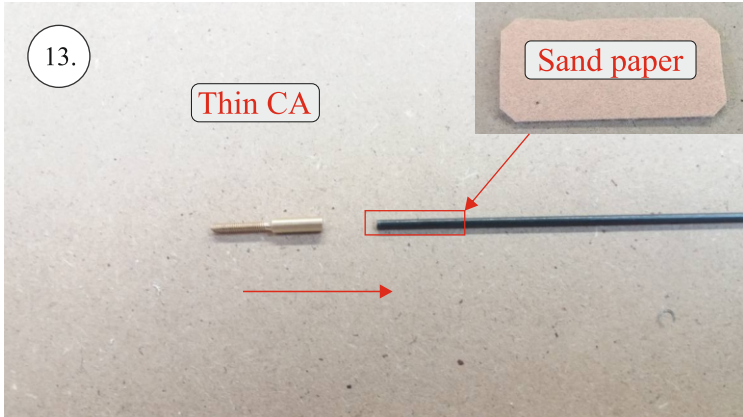
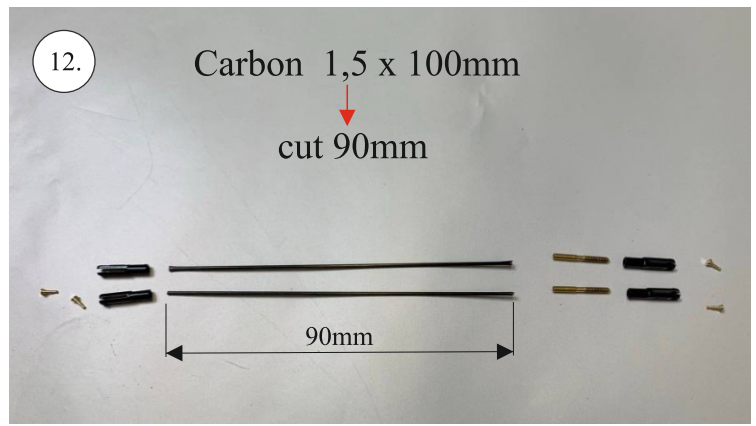
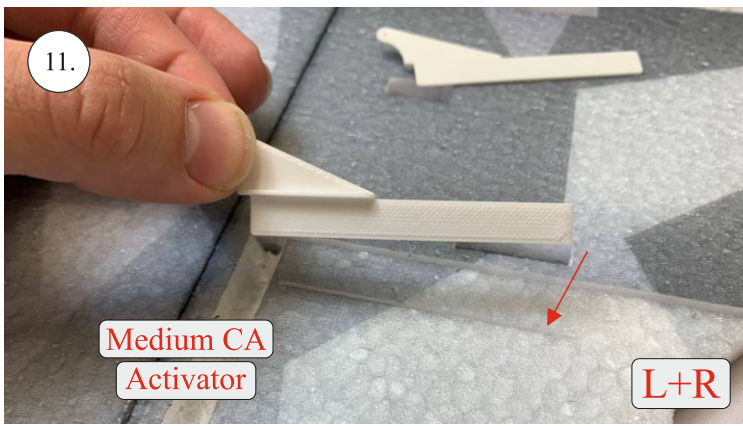

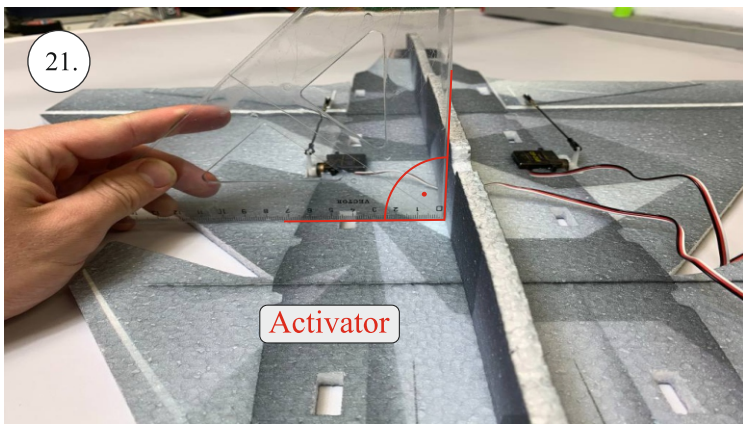

22.

Návod pokračuje dvou-motorovou verzí
Pro jedno-motorovou verzi přeskočte
na obr. 58

The two-engine version continues here,
for one engine version, skip to Pic. 58

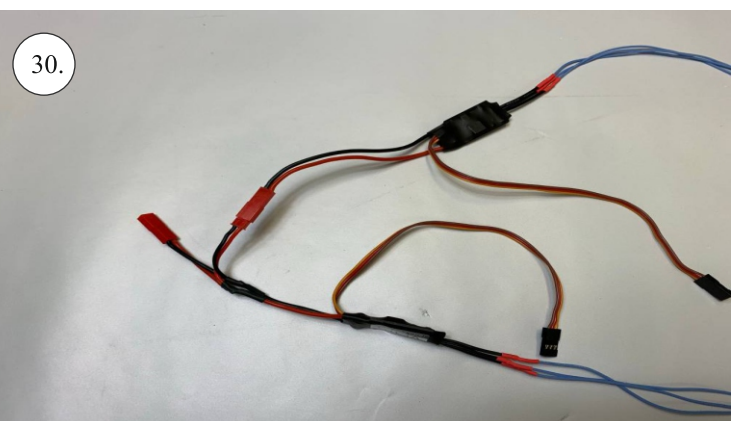
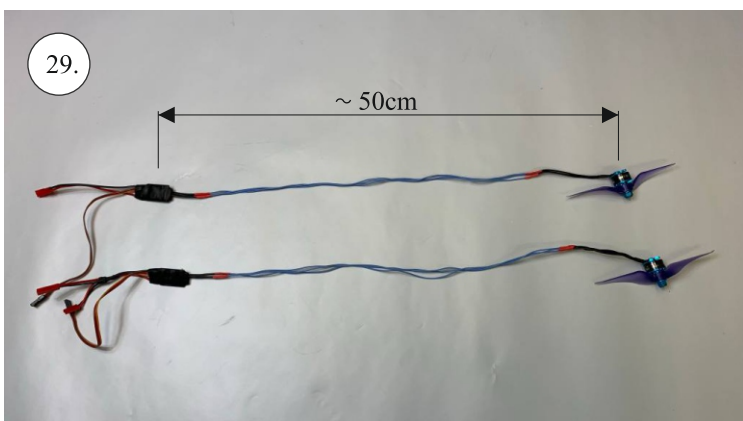
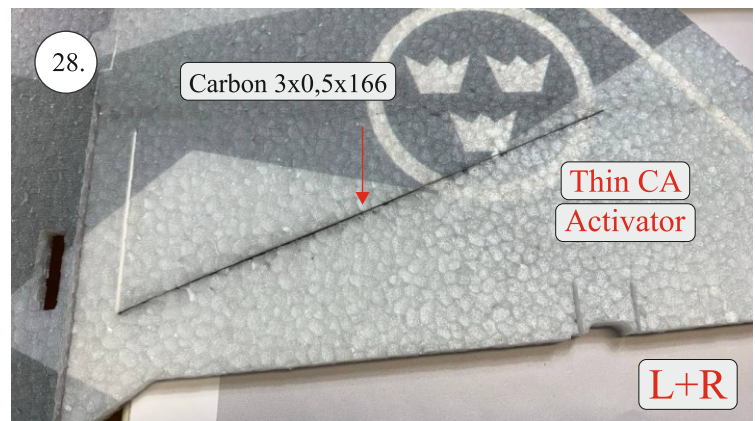
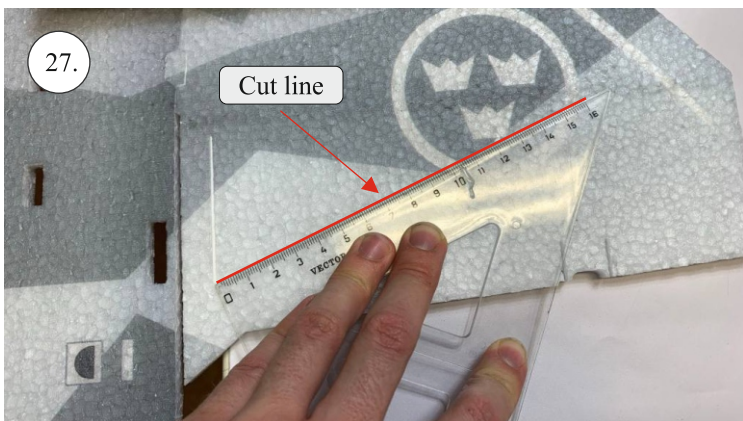
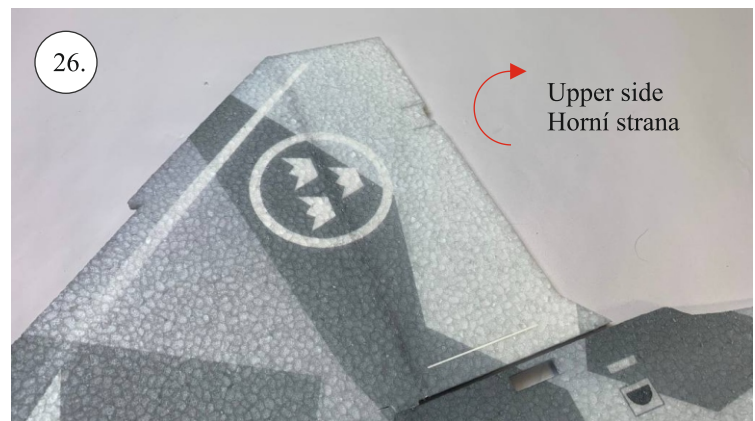
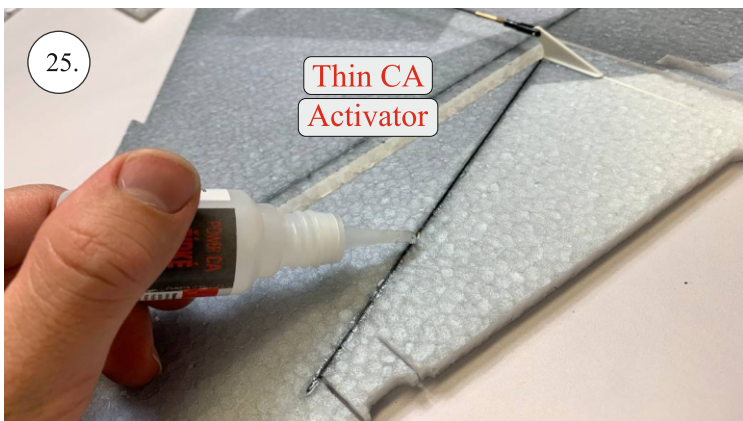
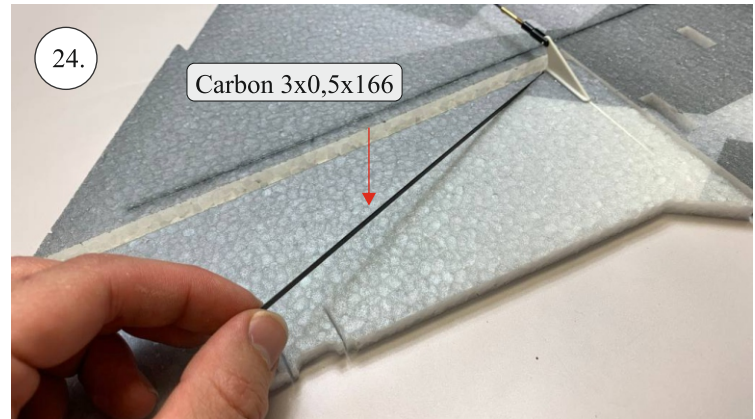
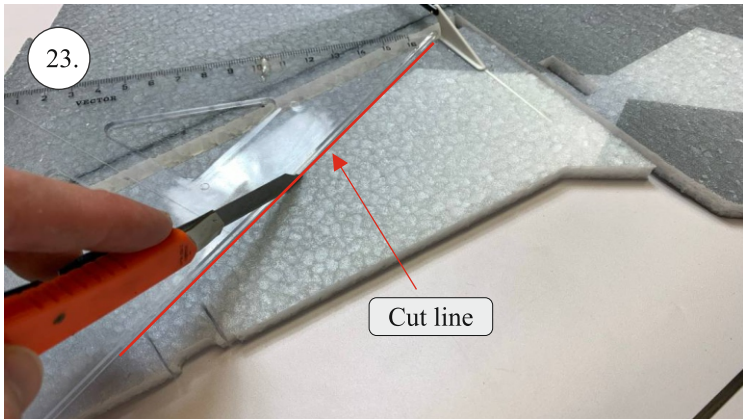

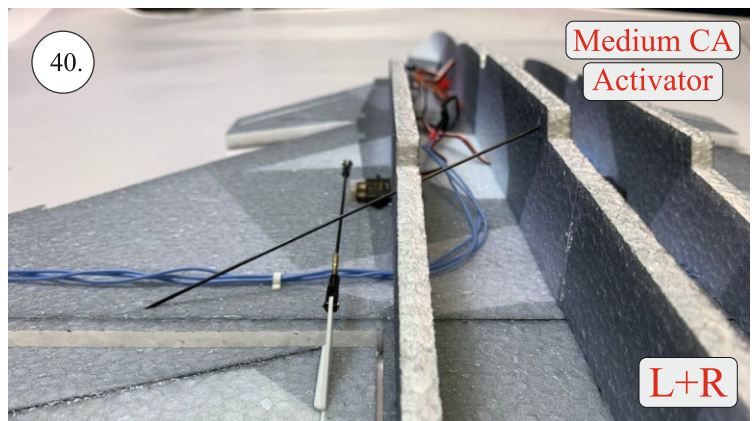
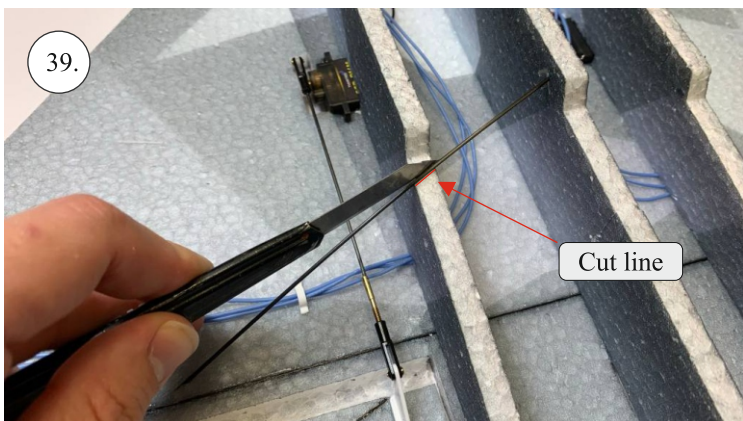
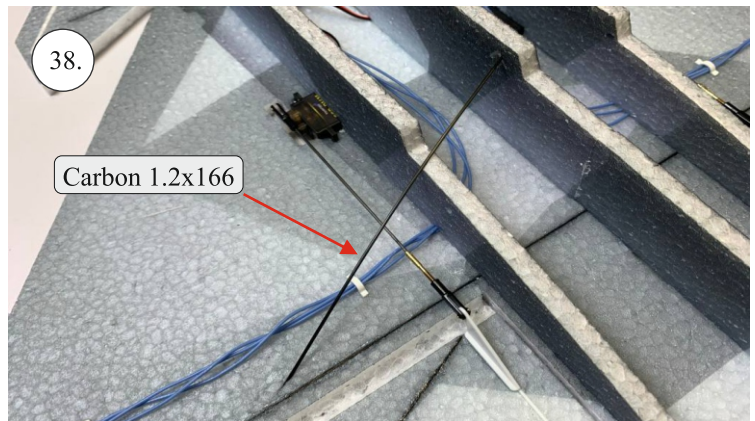
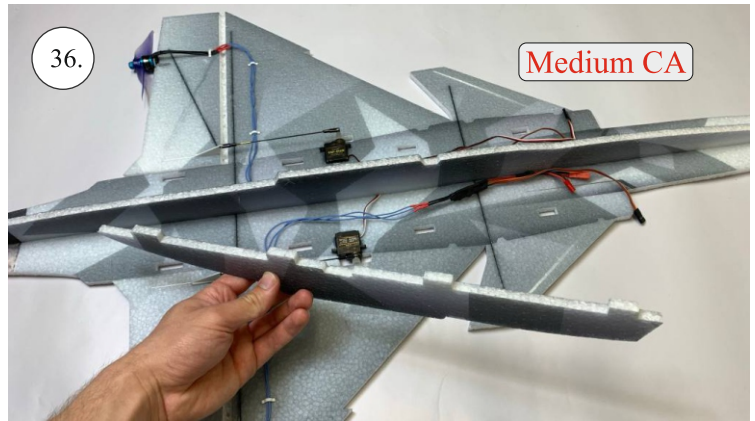
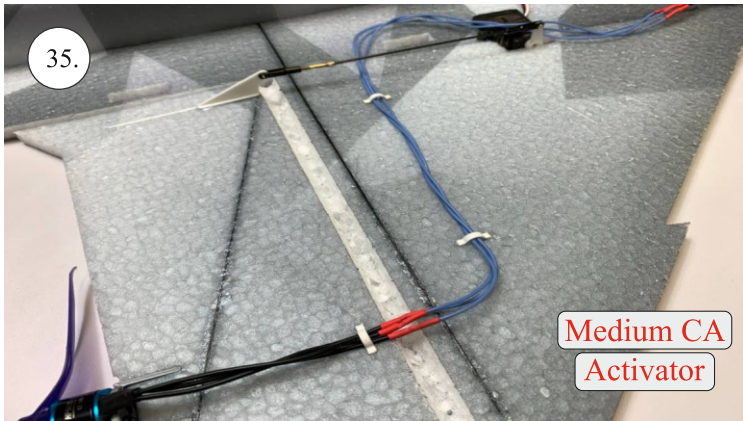
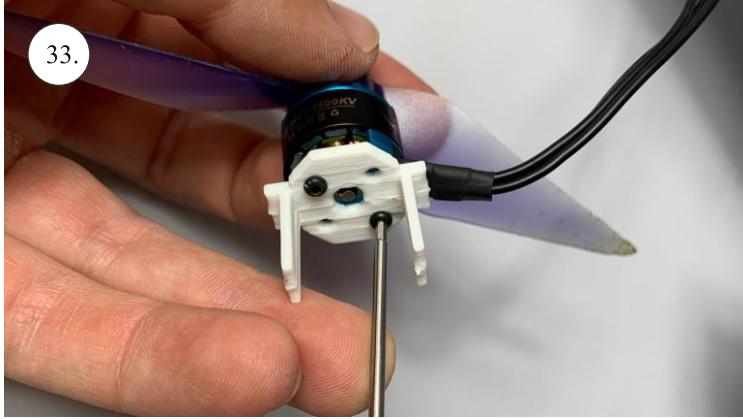
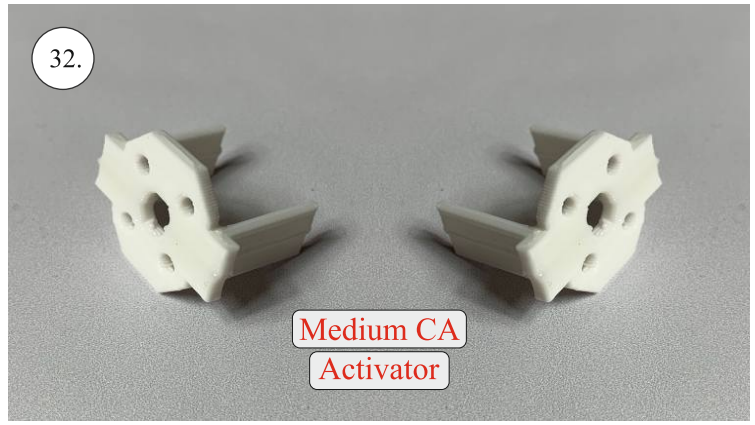
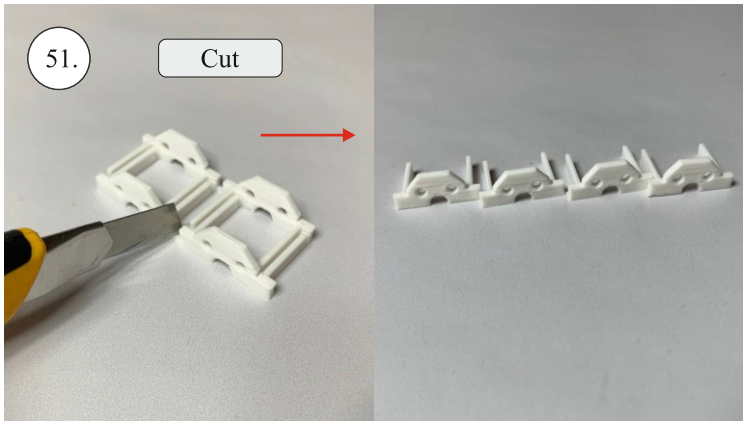

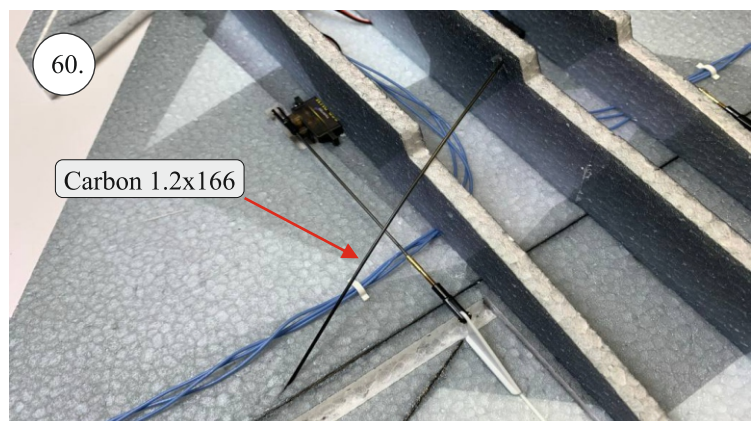
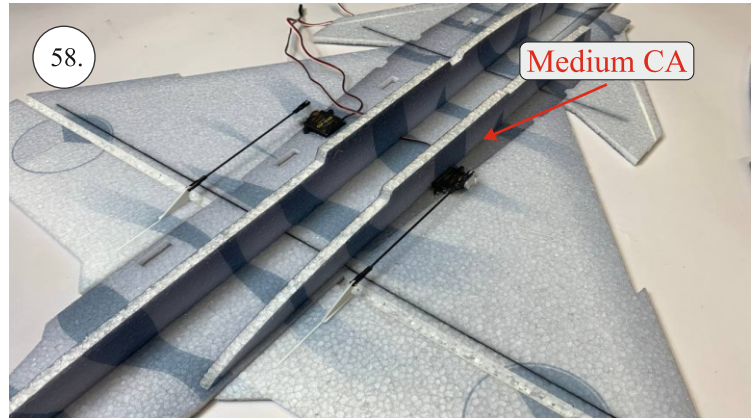
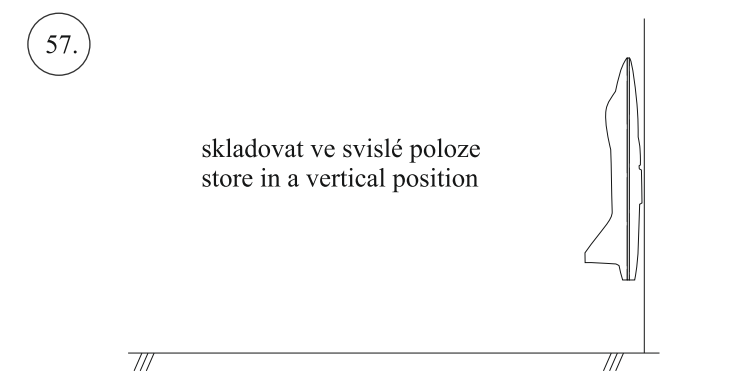
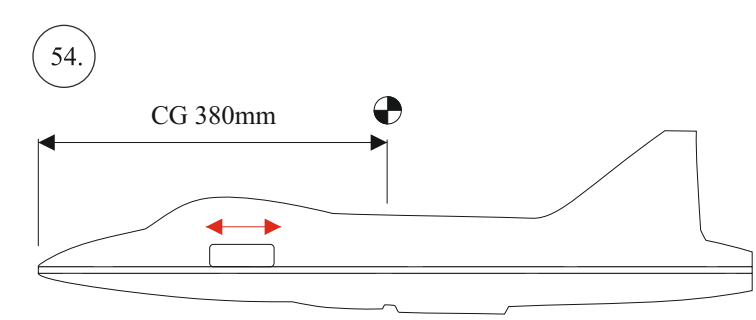
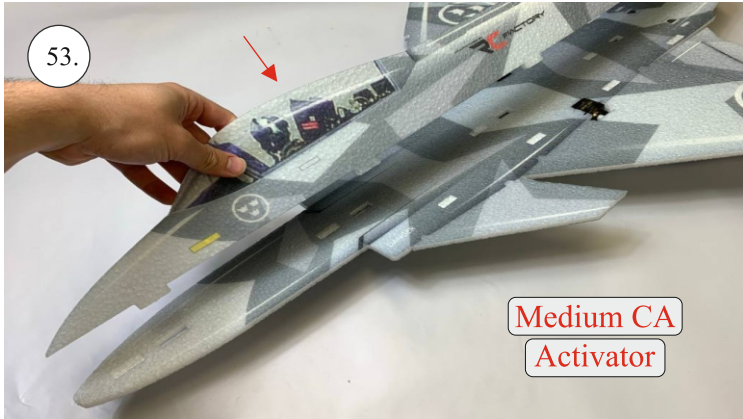
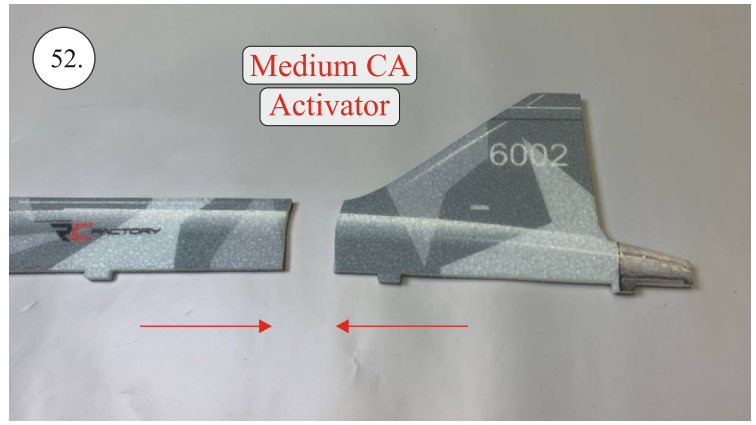
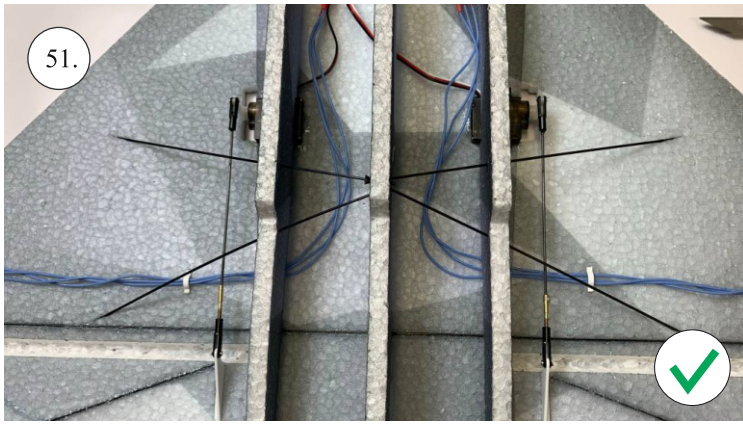

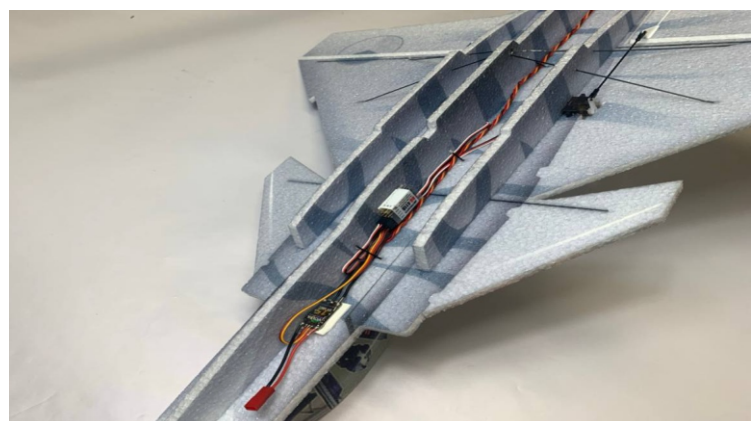
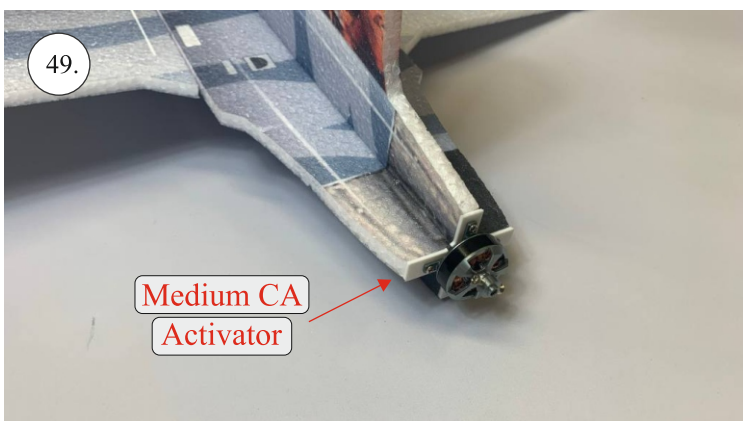
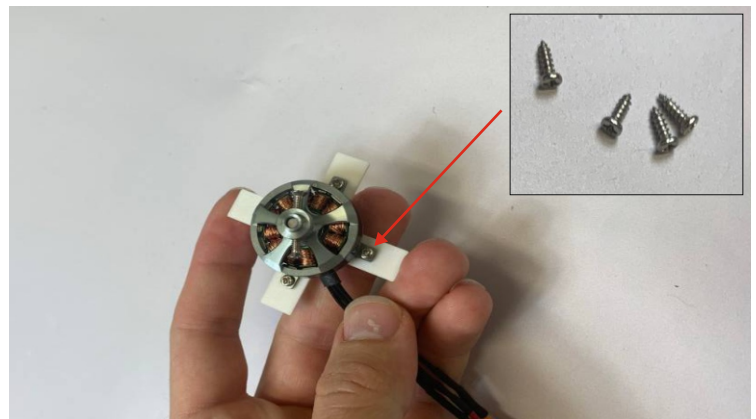
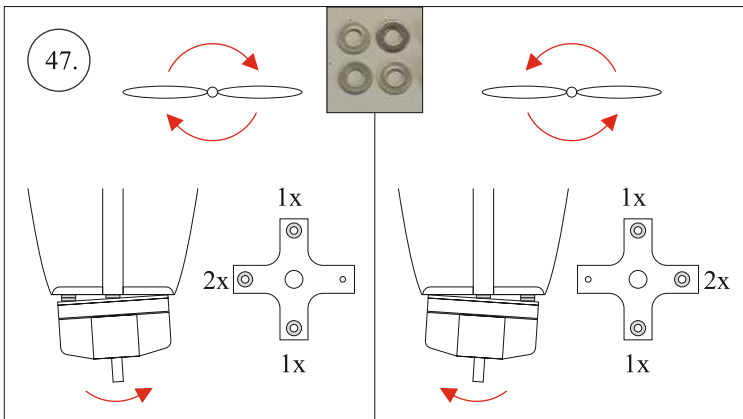
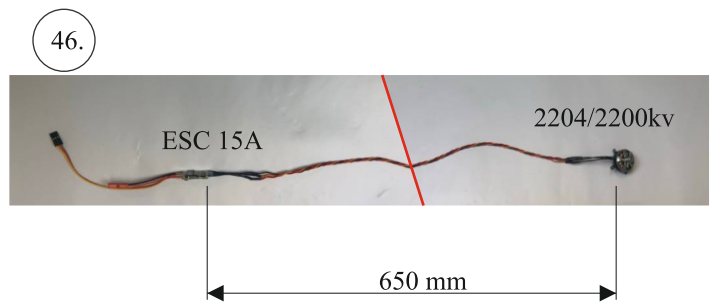
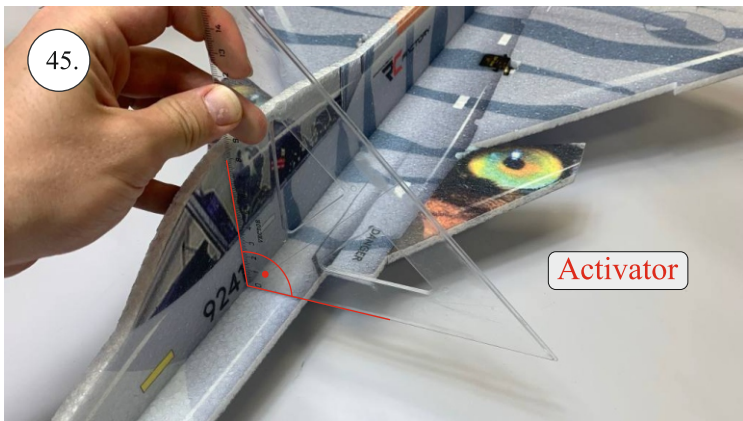
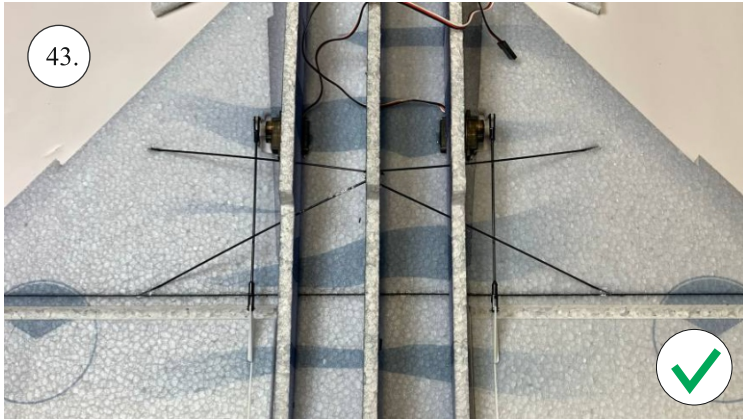
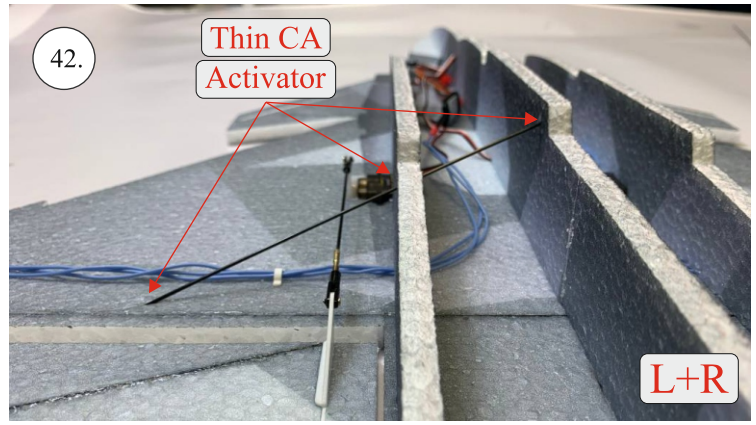
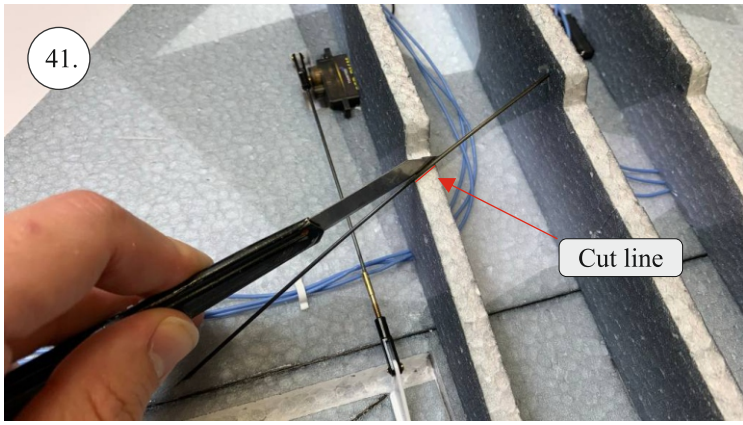

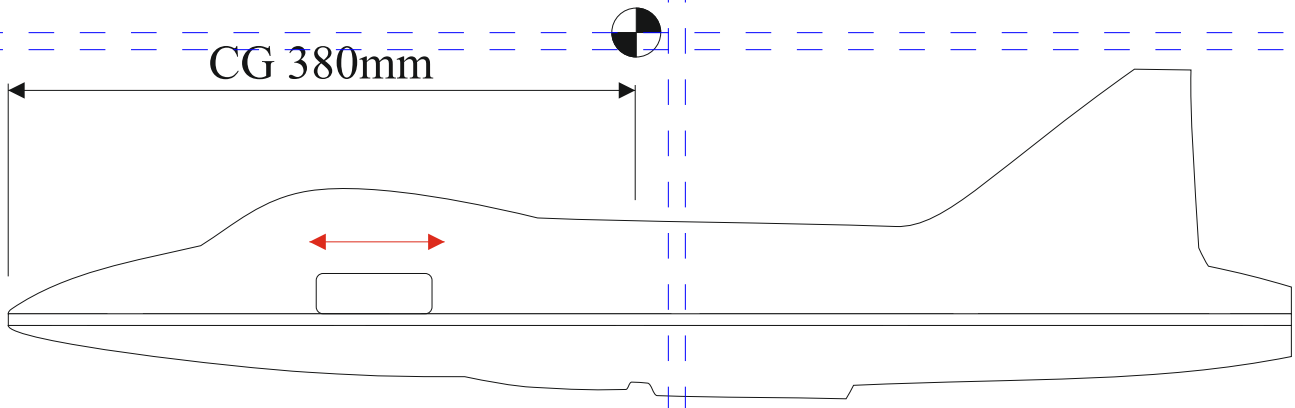

We wish you many happy flights.
Přejeme mnoho zábavy.

RC Factory team